

# PRATT PEDESTAL MOUNTED EYE WASH WITH BOWL & FOOT TREADLE

## COMPLIANCE

All PRATT emergency showers, and eye wash stations are designed and manufactured in an ISO 9001 accredited facility, with full conformance to both AS4775 and ANSI Z358.1 standard

**AEROSTREAM** technology delivers a gentle cascade of soft flow water to flush away any hazardous materials from the eyes and face.

**SWIRLTECH** technology delivers a precise pattern and controlled flow rate of a large volume of flushing fluid, ensuring optimum decontamination when its needed most.

**FCR/FCA** all showers & eyewashes come standard with Flow Control Regulators and/or Flow Control Adjuster. The shower FCR assists for simultaneous flow between the shower and eyewash to ensure minimum flow outputs are not compromised. The eyewash incorporates our FCA, allowing for the fine tuning of flow output.

## FEATURES

- Eyewash pipework and fittings are 304SS
- Stainless Steel Eye Wash Bowl
- Hand and Foot Operated via Push Handle and Foot Treadle
- Stainless-Steel Eyewash Assembly with Rubber Cups

## OPTIONAL ACCESSORIES

- Emergency Shower and/or Eyewash Signs
- Lighting
- Anti-Scald & Anti-Freeze Valves
- Shower Test Kit

Custom Modification where applicable



# PRATT PEDESTAL MOUNTED EYE WASH WITH BOWL & FOOT TREADLE

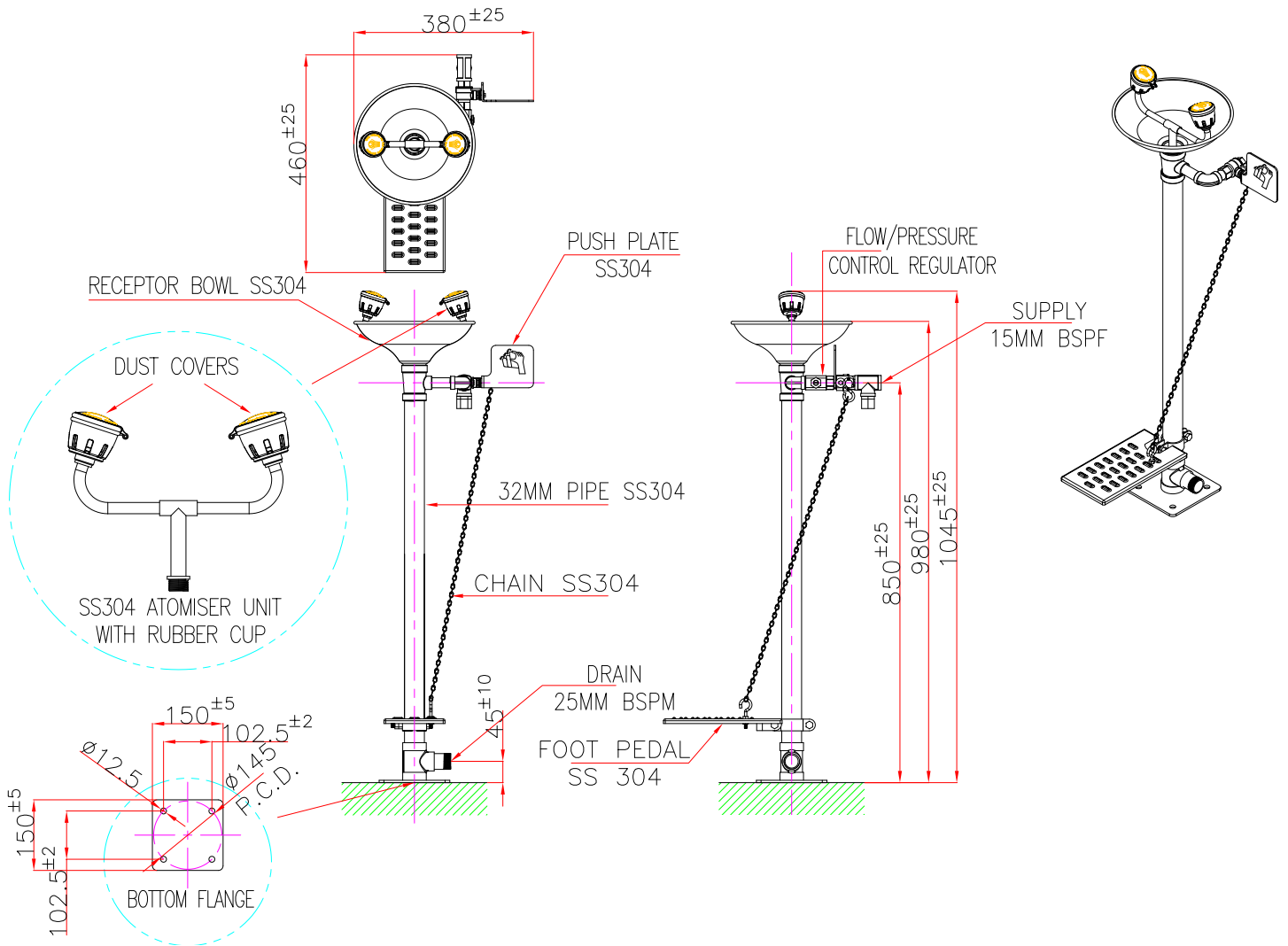

TECHNICAL INFORMATION	
<b>INLET CONNECTION</b>	15mm BSPF
<b>WATER SUPPLY-LINE SIZE</b>	15mm *Must be hydraulically sized to meet requirements.
<b>OUTLET CONNECTION</b>	25mm BSPM
<b>MINIMUM PERFORMANCE REQUIREMENTS</b>	210kPa / 30PSI *Caution should be taken when pressure exceeds 550 kPa
<b>FLOW OUTPUT (AT MIN PERFORMANCE REQUIREMENT)</b>	Shower 80 LPM Eye Wash 15 LPM Eye-Face Wash 30 LPM
<b>WEIGHT(KG)</b>	10
<b>DIMENSIONS(CM)</b>	79 X 29 X 20

Installation of emergency showers, eye and eye/face wash equipment shall be in accordance with AS/NZS4775 or ANSI Standard Z358.1 - whichever is applicable to the installation. PRATT Safety advises due to ongoing research and development, specifications may change without notice.

# SPARE PARTS

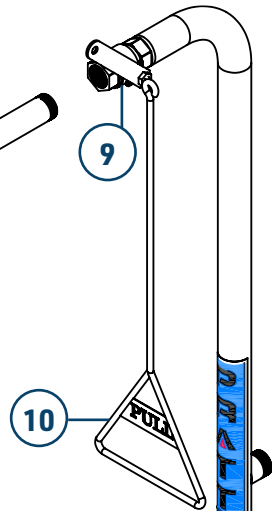
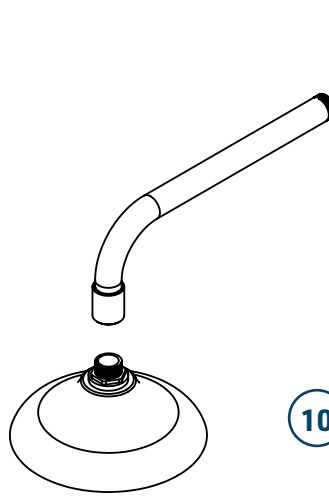
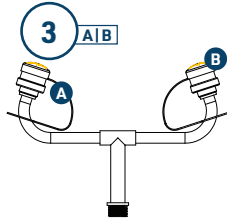
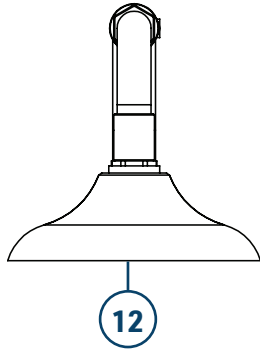
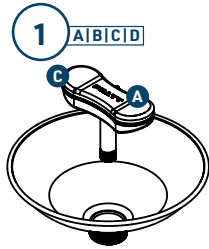
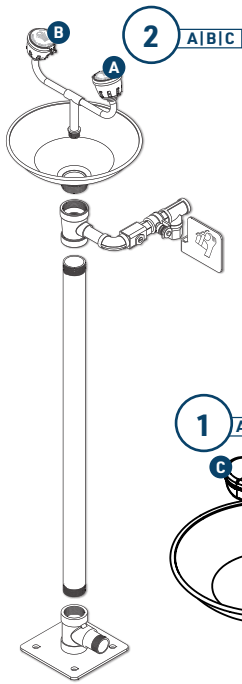

1	570027	PRATT EYE & FACE WASH NOZZLE YELLOW ABS PLASTIC SUITS ALL ELITE EYEWASH
1A	570029	PRATT DUST CAP ABS PLASTIC TO SUIT EYE & FACE WASH NOZZLE
1B	570030	PRATT SS304 SCREWS PACK OF 6 TO SUIT EYE & FACE WASH NOZZLE
1C	570031	PRATT AERATOR SUITS ALL EYE & FACE WASH INC. WASHER
1D	570032	PRATT 304 STAINLESS STEEL RING SUITS EYE & FACE WASH AERATOR
2	570003	PRATT EYEWASH NOZZLE ASSEMBLY S/STEEL WITH RUBBER EYECUP SUITS ALL ELITE EYEWASH
2A 3B	570018	PRATT AERATOR SUITS ALL ELITE AND ECONOMY EYEWASH
2B	570017	PRATT RUBBER EYEWASH CUP WITH YELLOW DUST CAP SUITS ALL ELITE EYEWASH
2C	570028	PRATT 304 STAINLESS STEEL RING SUITS EYEWASH AERATOR
3	570004	PRATT EYEWASH NOZZLE ASSEMBLY S/STEEL WITH YELLOW DUST CAP SUITS SE693 AND FTL EYEWASH
3A	570023	PRATT YELLOW DUST CAPS PLASTIC SUITS SE693 AND FTL EYEWASH
4	570006	PRATT S/STEEL EYEWASH BOWL SUITS ALL ELITE EYEWASH
5	570010	PRATT S/STEEL PUSH HANDLE FOR 570012 S/STEEL BALL VALVE SUITS ALL ELITE EYEWASH
6	570012	PRATT 15MM S/STEEL BALL VALVE FOR 570010 S/STEEL PUSH HANDLE SUITS ALL ELITE EYEWASH
7	570020	PRATT S/STEEL FOOT TREADLE SILVER SUITS ALL ELITE EYEWASH
8	570024	PRATT BLACK WASHER FOR STANCHION JOINT SUITS ALL ELITE SHOWERS
9	570014	PRATT 25mm S/STEEL BALL VALVE WITH LEVER ARM SUITS ALL ELITE SHOWERS
10	570016	PRAT S/STEEL PULL ROD SILVER SUITS ALL ELITE SHOWERS
11	570007	PRATT ABS PLASTIC SHOWER HEAD WITH SWIRLTEC NOZZLE SUITS ALL ELITE SHOWERS
12	570008	PRATT S/STEEL SHOWER HEAD WITH SWIRLTEC NOZZLE SUITS SE693

